

Cordón de contención
a: 8 h: 20 l: 70

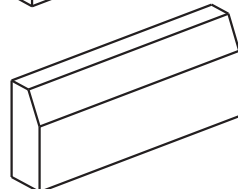

Cordón de contención
a: 10 h: 25 l: 70

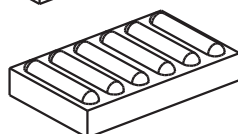

Separador de calzada
a: 32 h: 8 l: 52

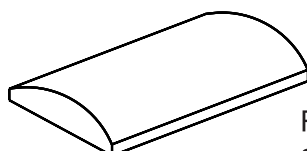

Reductor de velocidad
a: 50 h: 12 l: 80

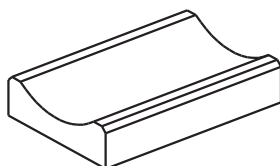

Cuneta
a: 40 h: 8-12 l: 60

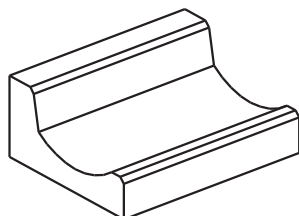

Cordón cuneta
a: 46 h: 25 l: 60

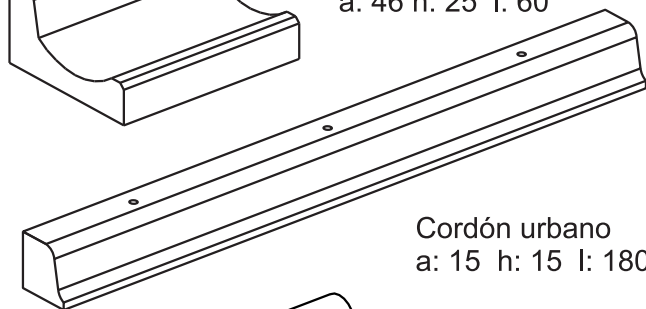

Cordón urbano
a: 15 h: 15 l: 180

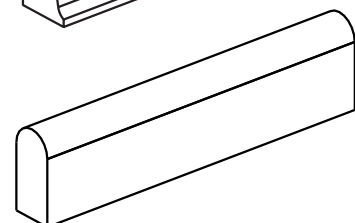

Cordón
a: 12 h: 25 l: 100

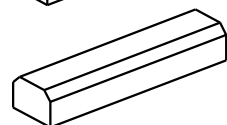

Cordón
a: 15 h: 10 l: 60



Cordón
a: 10 h: 20 l: 80

CORDONES Y TOPES DE RUEDAS

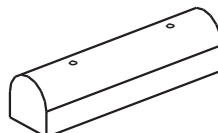

Cordón tope de rueda
a: 15 h: 15 l: 60

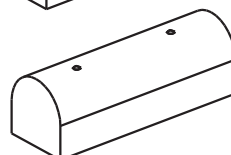

Cordón tope de rueda
a: 20 h: 20 l: 60

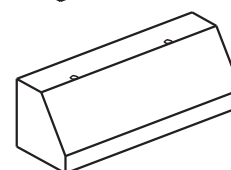

Cordón tope de rueda
a: 20 h: 20 l: 60

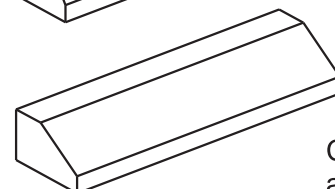

Cordón tope de rueda
a: 25 h: 15 l: 90

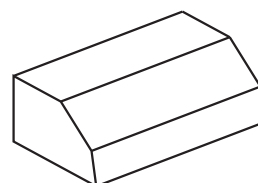

Cordón tope de rueda
a: 35 h: 20 l: 60

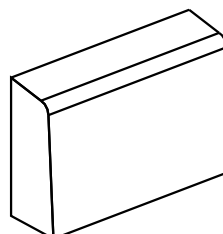

Cordón tope de rueda
a: 17 h: 40 l: 60



Cordón tope de rueda
a: 12 h: 20 l: 80

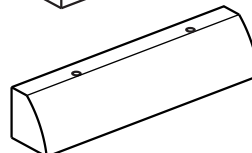

Cordón tope de rueda
a: 14 h: 14 l: 75

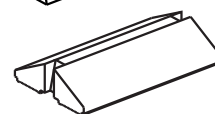

Cordón YPF
a: 30 h: 10 l: 50

